



CQ-2093

High-Speed Small-Sized Current Sensor

Overview

CQ-2093 is an open-type current sensor using a Hall sensor which outputs the analog voltage proportional to the AC/DC current. Quantum well ultra-thin film InAs (Indium Arsenide) is used as the Hall sensor, which enables the high-accuracy and high-speed current sensing. Simple AI-Shell® package with the Hall sensor, magnetic core, and primary conductor realizes the space-saving and high reliability.

Features

- Bidirectional type
- Electrical isolation between the primary conductor and the sensor signal
- 5V single supply operation
- Ratiometric output
- Low variation and low temperature drift of sensitivity and offset voltage
- Low noise output: 2.1mVrms (max.)
- Fast response time: 1 μ s (typ.)
- Small-sized surface mount package, halogen free

Functional Block Diagram

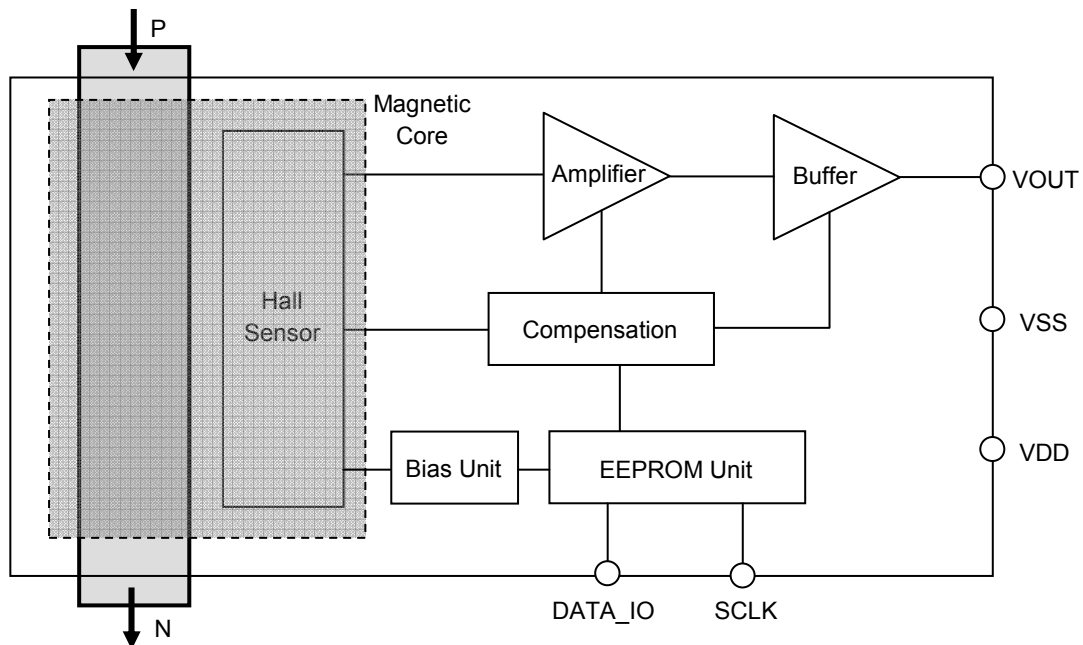

Figure 1. Functional block diagram of CQ-2093

Circuit Blocks

Table 1. Explanation of circuit blocks

Circuit Block	Function
Hall Sensor	Hall element which detects magnetic flux density generated from the measured current.
Amplifier	Amplifier of Hall element's output.
Buffer	Output buffer with gain. This block outputs the voltage (V_{OUT}) proportional to the current applied to the primary conductor.
Compensation	Compensation circuit which adjusts the temperature drifts of sensitivity and offset voltage.
Bias Unit	Drive circuit for Hall element.
EEPROM Unit	Non-volatile memory for setting adjustment parameters. The parameters are adjusted before the shipment.
Magnetic Core	Magnetic core which gathers the magnetic flux density to the Hall element.

Typical Output Characteristics

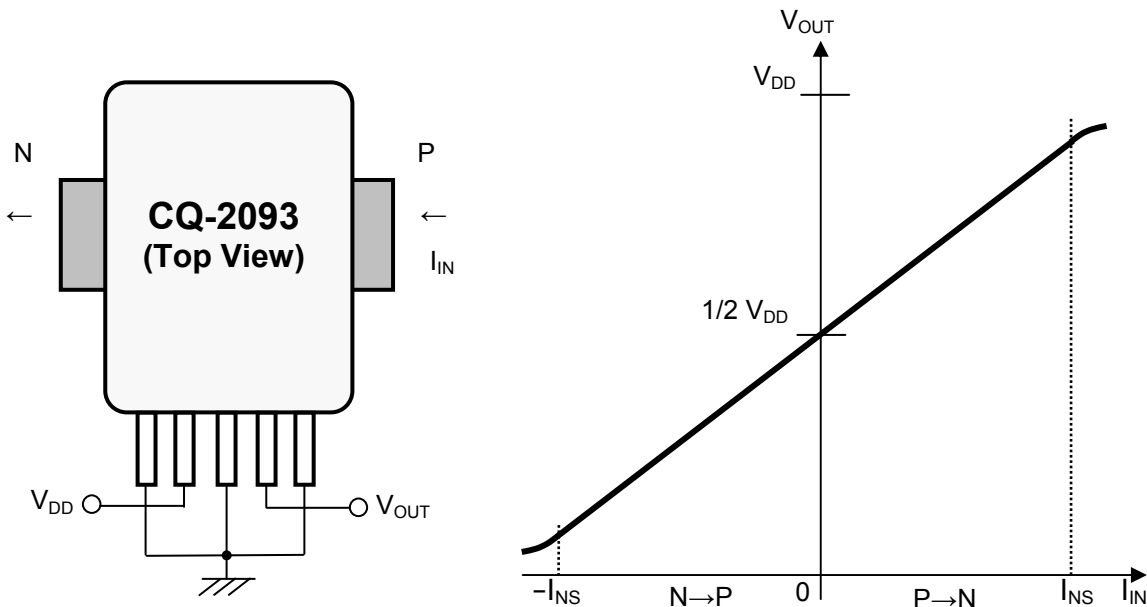

Figure 2. Typical output characteristics of CQ-2093

Pin/Function

Table 2. Pin-out description

No.	Name	I/O	Description
1	DATA_IO	-	Test pin (connect to ground)
2	VDD	-	Power supply pin (5V)
3	VSS	-	Ground pin (0V)
4	VOUT	O	Analog output pin
5	SCLK	-	Test pin (connect to ground)
6	P	I	Primary current pin (+)
7	N	I	Primary current pin (-)

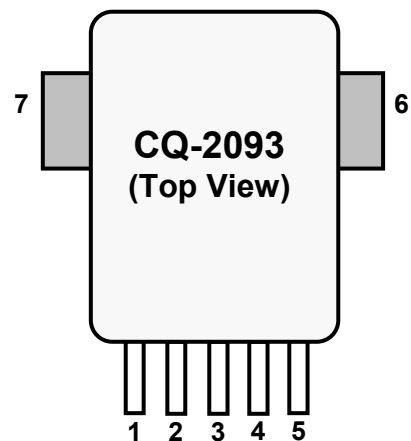

Figure 3. Pin-out diagram

Absolute Maximum Ratings

Table 3. Absolute maximum ratings

Parameter	Symbol	Min.	Max.	Units	Notes
Supply Voltage	V _{DD}	-0.3	6	V	VDD
Analog Output Current	I _{OUT}	-1	1	mA	VOUT
Storage Temperature	T _{stg}	-40	125	°C	

WARNING: Operation at or beyond these limits may result in permanent damage to the device. Normal operation is not guaranteed at these extremes.

Primary Current Derating Curve

Conditions: Mounted on the test board complying with the EIA/JEDEC Standards (EIA/JESD 51.)

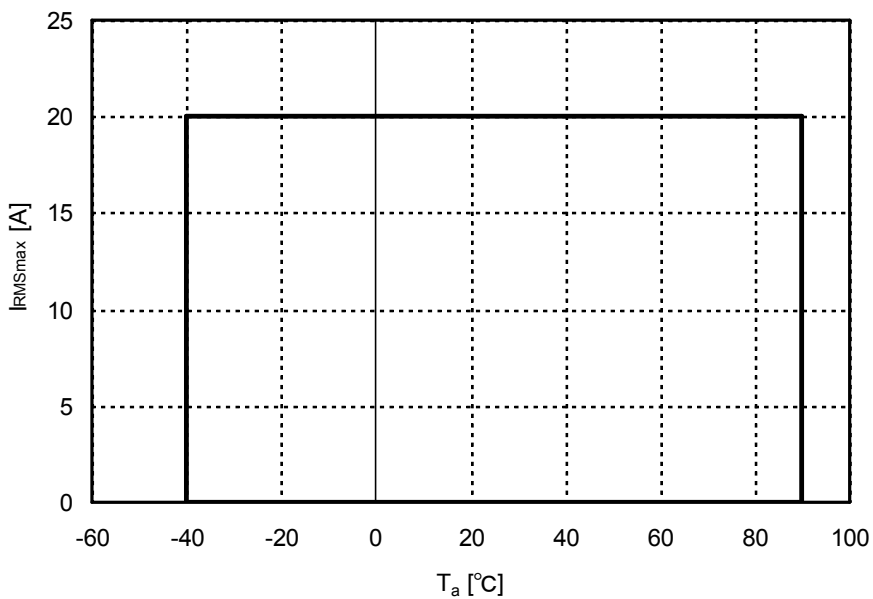

Figure 4. Primary current derating curve of CQ-2093

Recommended Operating Conditions

Table 4. Recommended operating conditions

Parameter	Symbol	Min.	Typ.	Max.	Units	Notes
Supply Voltage	V _{DD}	4.5	5.0	5.5	V	
Output Current	I _{OUT}	-0.5		0.5	mA	VOUT
Output Load Capacitance	C _L			100	pF	VOUT
Operating Ambient Temperature	T _a	-40		90	°C	

NOTE: Electrical characteristics are not guaranteed when operated at or beyond these conditions.

Electrical Characteristics

Table 5. Electrical characteristicsConditions (unless otherwise specified): $T_a=25^{\circ}\text{C}$, $V_{DD}=5\text{V}$

Parameter	Symbol	Conditions	Min.	Typ.	Max.	Units
Maximum Primary Current (RMS)	I_{RMSmax}	$T_a=-40\sim 90^{\circ}\text{C}$	-20		20	A
Current Consumption	I_{DD}	No Loads			9	mA
Sensitivity*	V_h		58.8	60.0	61.2	mV/A
Offset Voltage*	V_{of}	$I_{IN}=0\text{A}$	2.423	2.500	2.577	V
Linear Sensing Range	I_{NS}		-35		35	A
Linearity Error*	ρ		-1		1	%F.S.
Rise Response Time	t_r	$I_{IN} 90\% \rightarrow V_{OUT} 90\%$ $C_L=100\text{pF}$		1		μs
Fall Response Time	t_f	$I_{IN} 10\% \rightarrow V_{OUT} 10\%$ $C_L=100\text{pF}$		1		μs
Bandwidth	f_T	-3dB, $C_L=100\text{pF}$		400		kHz
Output Noise**	V_{Nrms}				2.1	mVrms
Temperature Drift of Sensitivity at High Temperature**	V_{h-dH}	Variation ratio to $V_h(T_a=35^{\circ}\text{C})$ $T_a=35\sim 90^{\circ}\text{C}$	-2		2	%
Maximum Temperature Drift of Sensitivity at Low Temperature	$V_{h-dLmax}$	Variation ratio to $V_h(T_a=35^{\circ}\text{C})$ $T_a=-40\sim 35^{\circ}\text{C}$		± 2		%
Maximum Temperature Drift of Offset voltage	$V_{of-dmax}$	Variation from $V_{of}(T_a=35^{\circ}\text{C})$ $T_a=-40\sim 90^{\circ}\text{C}$, $I_{IN}=0\text{A}$		± 17.5		mV
Ratiometricity Error of Sensitivity**	V_{h-R}	$V_{DD}=4.5\text{V}\sim 5.5\text{V}$	-1		1	%
Ratiometricity Error of Offset Voltage**	V_{of-R}	$V_{DD}=4.5\text{V}\sim 5.5\text{V}$ $I_{IN}=0\text{A}$	-1		1	%
Primary Conductor Resistance	R_1			340		$\mu\Omega$
Isolation Voltage**	V_{INS}	AC 50/60Hz, 60s	2.5			kV
Isolation Resistance**	R_{INS}	DC 1kV	500			M Ω

* These parameters can drift by the values described in 'Reliability Tests' section over the lifetime of the product.

** These characteristics are guaranteed by design.

Characteristics Definitions

(1) Sensitivity V_h [mV/mT], offset voltage V_{of} [V]

Sensitivity is defined as the slope of the approximate straight line calculated by the least square method, using the data of V_{OUT} voltage (V_{OUT}) when the primary current (I_{IN}) is swept within the range of linear sensing range (I_{NS}). Offset voltage is defined as the intercept of the approximate straight line above.

(2) Linearity error ρ [%F.S.]

Linearity error is defined as the ratio of the maximum error voltage (V_d) to the full scale (F.S.), where V_d is the maximum difference between the V_{OUT} voltage (V_{OUT}) and the approximate straight line calculated in the sensitivity and offset voltage definition. Definition formula is shown in below:

$$\rho = V_d / F.S. \times 100$$

NOTE) Full scale (F.S.) is defined by the multiplication of the linear sensing range and sensitivity (See Figure 5).

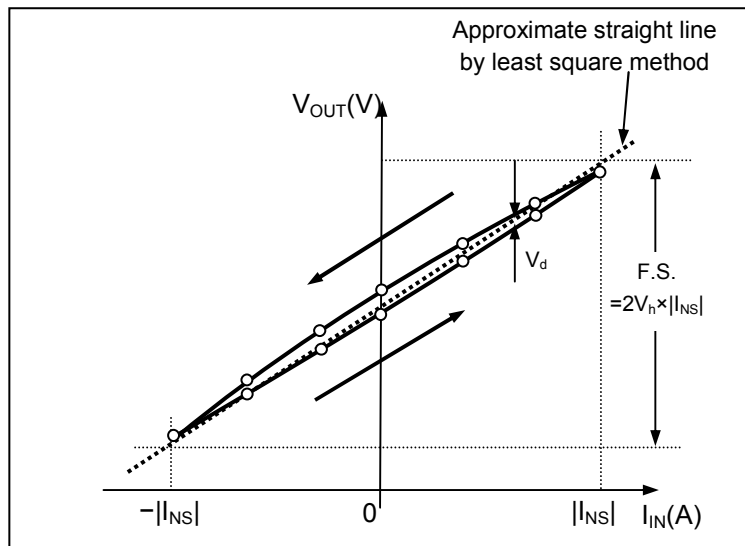

Figure 5. Output characteristics of CQ-2093

(3) Ratiometric error of sensitivity V_{h-R} [%] and ratiometric error of offset voltage V_{of-R} [%]

Output of CQ-2093 is ratiometric, which means the values of sensitivity (V_h) and offset voltage (V_{of}) are proportional to the supply voltage (V_{DD}). Ratiometric error is defined as the difference between the V_h (or V_{of}) and ideal V_h (or V_{of}) when the V_{DD} is changed from 5.0V to V_{DD1} ($4.5V < V_{DD1} < 5.5V$). Definition formula is shown in below:

$$V_{h-R} = 100 \times \{ (V_h(V_{DD} = V_{DD1}) / V_h(V_{DD} = 5V)) - (V_{DD1} / 5) \} / (V_{DD1} / 5)$$

$$V_{of-R} = 100 \times \{ (V_{of}(V_{DD} = V_{DD1}) / V_{of}(V_{DD} = 5V)) - (V_{DD1} / 5) \} / (V_{DD1} / 5)$$

(4) Temperature drift of sensitivity V_{h-d} [%]

Temperature drift of sensitivity is defined as the drift ratio of the sensitivity (V_h) at $T_a = T_{a1}$ ($-40^\circ\text{C} < T_{a1} < 90^\circ\text{C}$) to the V_h at $T_a = 35^\circ\text{C}$, and calculated from the formula below:

$$V_{h-d} = 100 \times (V_h(T_{a1}) / V_h(35^\circ\text{C}) - 1)$$

Temperature drift of sensitivity at high temperature (V_{h-dH}) is defined as the V_{h-d} at an arbitrary T_{a1} ($35^\circ\text{C} < T_{a1} < 90^\circ\text{C}$) and maximum temperature drift of at low temperature range ($V_{h-dLmax}$) is defined as the maximum value of $|V_{h-d}|$ through $-40^\circ\text{C} < T_{a1} < 35^\circ\text{C}$. (continued)

Reference data of the temperature drift of sensitivity of CQ-2093 is shown in Figure 6.

(5) Temperature drift of offset voltage V_{of-d} [mV]

Temperature drift of offset voltage is defined as the drift value between the offset voltage (V_{of}) at $T_a=T_{a1}$ ($-40^{\circ}\text{C}<T_{a1}<90^{\circ}\text{C}$) and the V_{of} at $T_a=35^{\circ}\text{C}$, and calculated from the formula below:

$$V_{of-d} = V_{of}(T_a = T_{a1}) - V_{of}(T_a = 35^{\circ}\text{C})$$

Maximum temperature drift of offset voltage ($V_{of-dmax}$) is defined as the maximum value of $|V_{h-d}|$ through $-40^{\circ}\text{C}<T_{a1}<90^{\circ}\text{C}$.

Reference data of the temperature drift of offset voltage of CQ-2093 is shown in Figure 7.

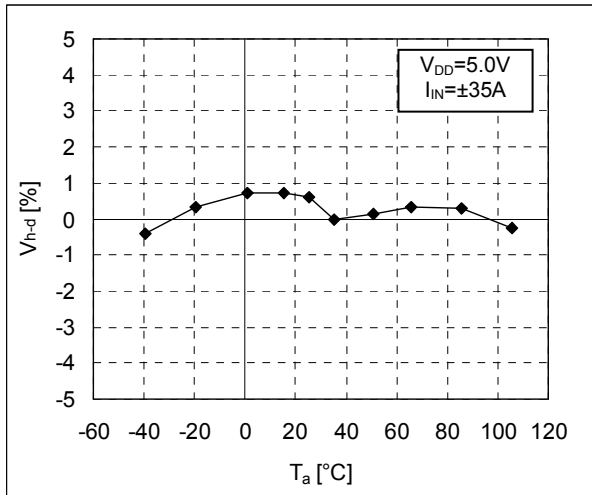

Figure 6. Temperature drift of sensitivity of CQ-2093 (for reference, n=1)

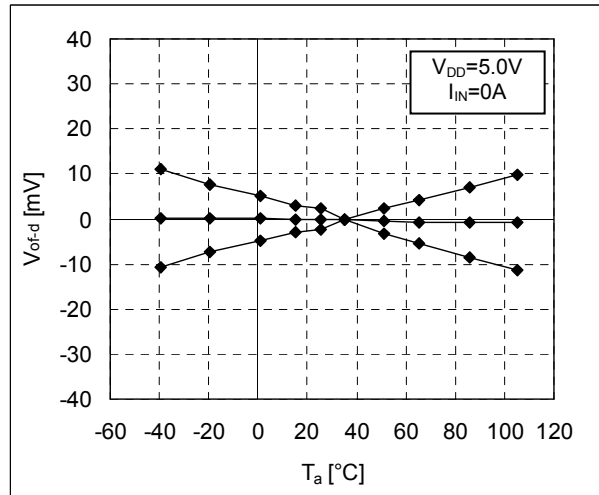

Figure 7. Temperature drift of offset voltage of CQ-2093 (for reference, n=3)

(6) Rise response time t_r [μs] and fall response time t_f [μs]

Rise response time (or fall response time) is defined as the time delay from the 90% (or 10%) of input primary current (I_{IN}) to the 90% (or 10%) of the V_{OUT} voltage (V_{OUT}) under the pulse input of primary current (see Figure 8.)

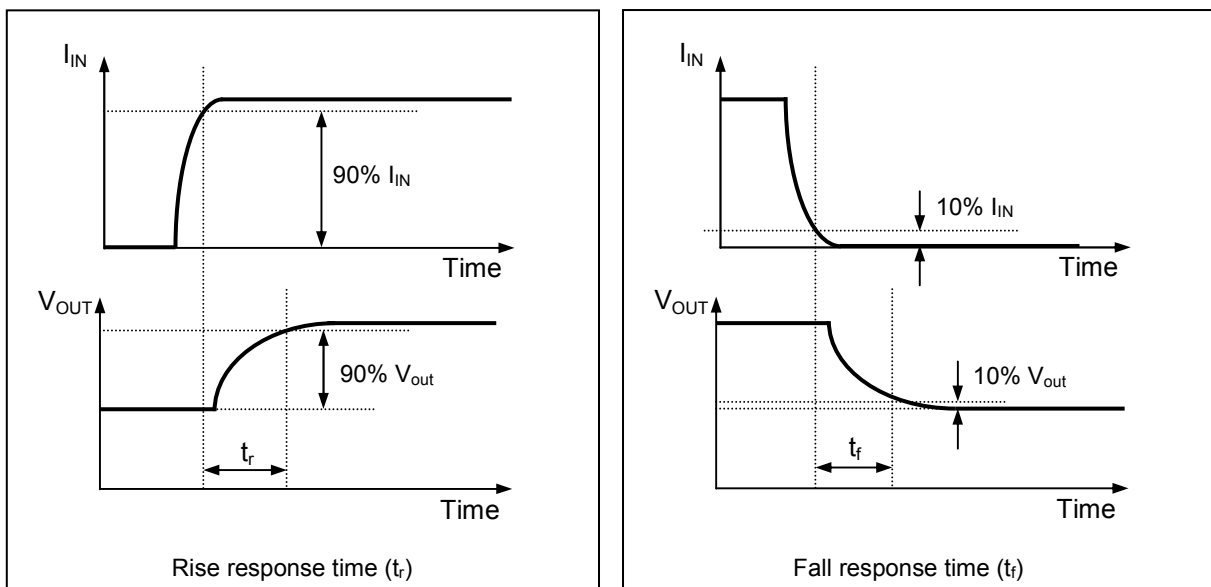
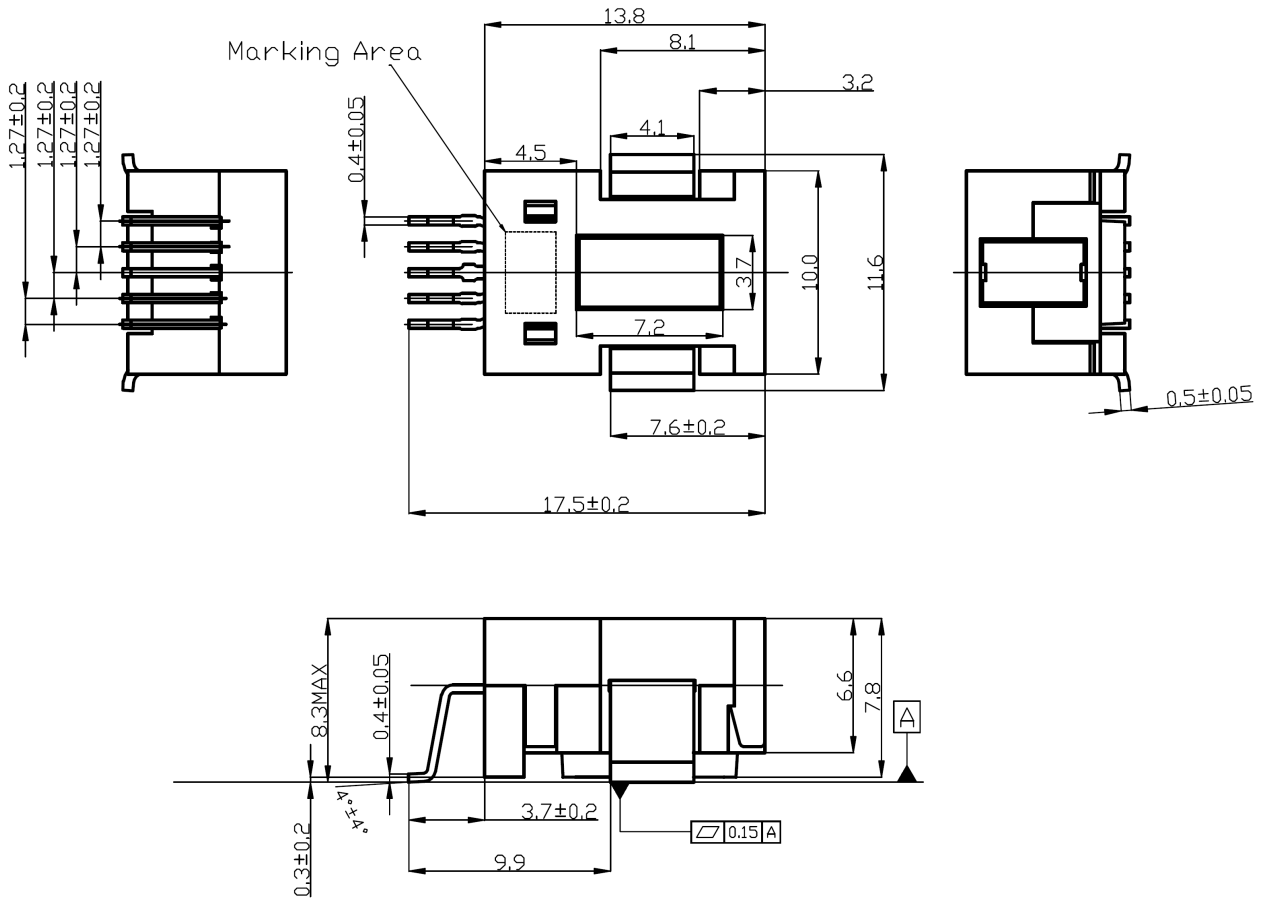

Figure 8. Definition of response time

Package Dimensions



Unit:mm

Note1) The tolerances of dimensions without any mention are ±0.1mm.

Note2) Package contains some adhesive materials (RoHS compliant, halogen free) to hold the magnetic core.

Terminals: Cu

Plating for Terminals: Sn (100%)

RoHS compliant, halogen free

Figure 9. Package outline

Recommended Land Pattern (Reference Only)

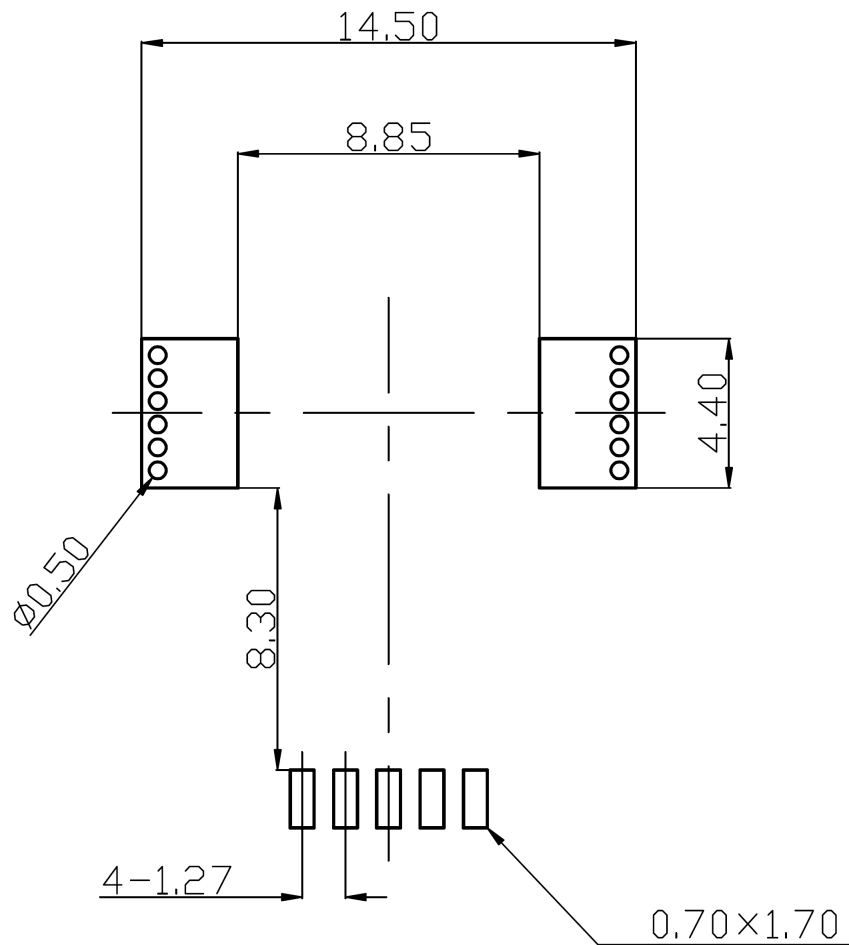

Unit:mm

Figure 10. Recommended land pattern of CQ-2093

Note) If 2 or more trace layers are used as the current path, please make enough number of through-holes to flow current between the trace layers.

Application Circuits

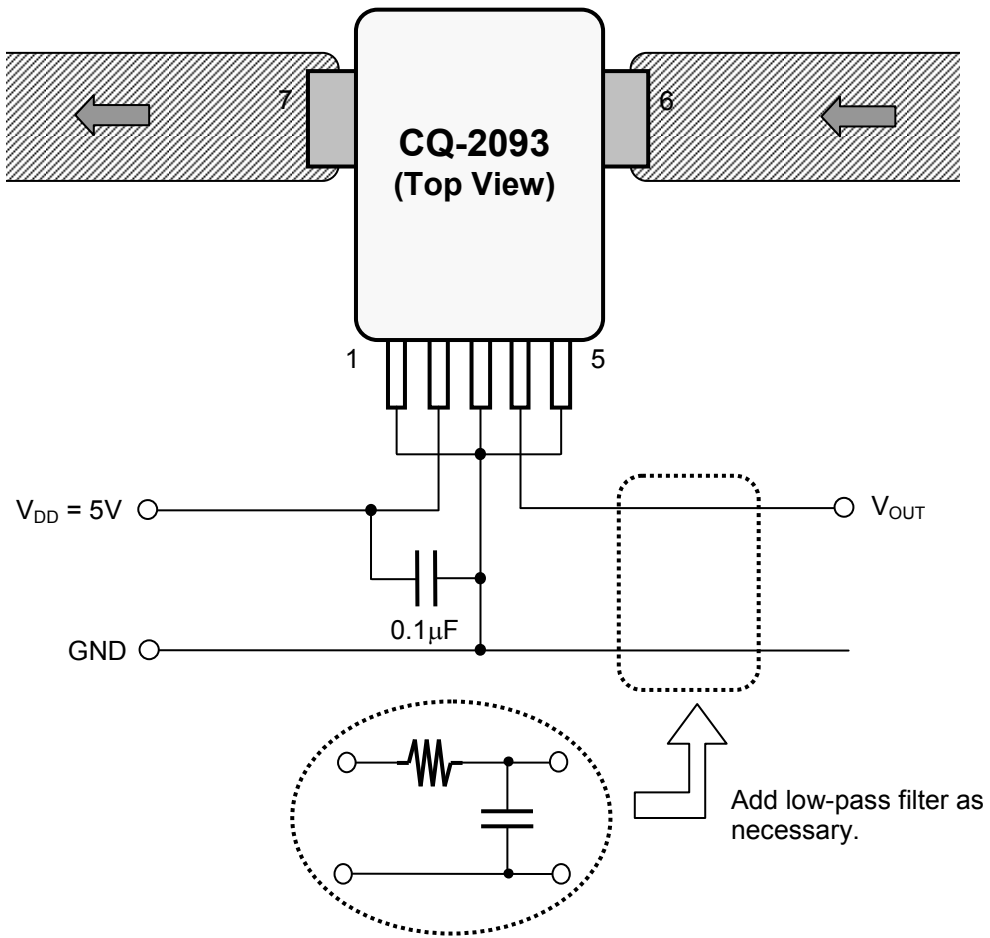

Figure 11. Application Circuits of CQ-2093

Markings

Production information is printed on the package surface by laser marking. Markings consist of 12 characters (6 characters × 2 lines).

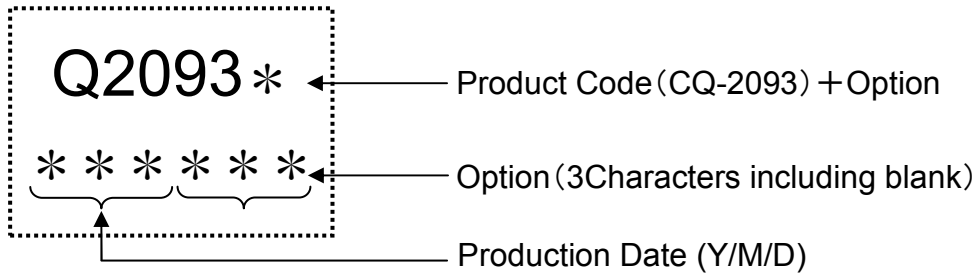

Figure 12. Markings of CQ-2093

Table 6. Production date code table

Last Number of Year		Month		Day	
Character	Number	Character	Month	Character	Day
0	0	C	Jan.	1	1
1	1	D	Feb.	2	2
2	2	E	Mar.	3	3
3	3	F	Apr.	4	4
4	4	G	May.	5	5
5	5	H	Jun.	6	6
6	6	J	Jul.	7	7
7	7	K	Aug.	8	8
8	8	L	Sep.	9	9
9	9	M	Oct.	0	10
		N	Nov.	A	11
		P	Dec.	B	12
				C	13
				D	14
				E	15
				F	16
				G	17
				H	18
				J	19
				K	20
				L	21
				N	22
				P	23
				R	24
				S	25
				T	26
				U	27
				V	28
				W	29
				X	30
				Y	31

Reliability Tests

Table 7. Test parameters and conditions of reliability test

No.	Test Parameter	Test Conditions	n	Test Time
1	High Humidity Storage Test	【JEITA EIAJ ED-4701 102】 T _a =85°C, 85%RH, continuous operation	22	1000h
2	High Temperature Bias Test	【JEITA EIAJ ED-4701 101】 T _a =125°C, continuous operation	22	1000h
3	High Temperature Storage Test	【JEITA EIAJ ED-4701 201】 T _a =150°C	22	1000h
4	Low Temperature Storage Test	【JEITA EIAJ ED-4701 202】 T _a = -55°C	22	1000h
5	Heat Cycle Test	【JEITA EIAJ ED-4701 105】 -40°C ↔ 25°C ↔ 125°C 30min. ↔ 5min. ↔ 30min. Tested in vapor phase	22	100 cycles
6	Vibration Test	【JEITA EIAJ ED-4701 403】 Vibration frequency: 10~55Hz (1min.) Vibration amplitude: 1.5mm (x, y, z directions)	5	2h for each direction

Tested samples are pretreated as below before each reliability test:

Desiccation: 125°C /24h → Moisture Absorption: 85°C/85%RH/168h → Reflow: 3 times (JEDEC Level1)

Criteria:

Products whose drifts before and after the reliability tests do not exceed the values below are considered to be in spec.

Sensitivity V _h (T _a =25°C)	: Within ±1.5%
Offset Voltage V _{of} (T _a =25°C)	: Within ±100mV
Linearity ρ (T _a =25°C)	: Within ±1%

IMPORTANT NOTICE

- These products and their specifications are subject to change without notice.
When you consider any use or application of these products, please make inquiries the sales office of Asahi Kasei Microdevices Corporation (AKM) or authorized distributors as to current status of the products.
- Descriptions of external circuits, application circuits, software and other related information contained in this document are provided only to illustrate the operation and application examples of the semiconductor products. You are fully responsible for the incorporation of these external circuits, application circuits, software and other related information in the design of your equipments. AKM assumes no responsibility for any losses incurred by you or third parties arising from the use of these information herein. AKM assumes no liability for infringement of any patent, intellectual property, or other rights in the application or use of such information contained herein.
- Any export of these products, or devices or systems containing them, may require an export license or other official approval under the law and regulations of the country of export pertaining to customs and tariffs, currency exchange, or strategic materials.
- AKM products are neither intended nor authorized for use as critical components_{Note1}) in any safety, life support, or other hazard related device or system_{Note2}), and AKM assumes no responsibility for such use, except for the use approved with the express written consent by Representative Director of AKM. As used here:
Note1) A critical component is one whose failure to function or perform may reasonably be expected to result, whether directly or indirectly, in the loss of the safety or effectiveness of the device or system containing it, and which must therefore meet very high standards of performance and reliability.
Note2) A hazard related device or system is one designed or intended for life support or maintenance of safety or for applications in medicine, aerospace, nuclear energy, or other fields, in which its failure to function or perform may reasonably be expected to result in loss of life or in significant injury or damage to person or property.
- It is the responsibility of the buyer or distributor of AKM products, who distributes, disposes of, or otherwise places the product with a third party, to notify such third party in advance of the above content and conditions, and the buyer or distributor agrees to assume any and all responsibility and liability for and hold AKM harmless from any and all claims arising from the use of said product in the absence of such notification.